

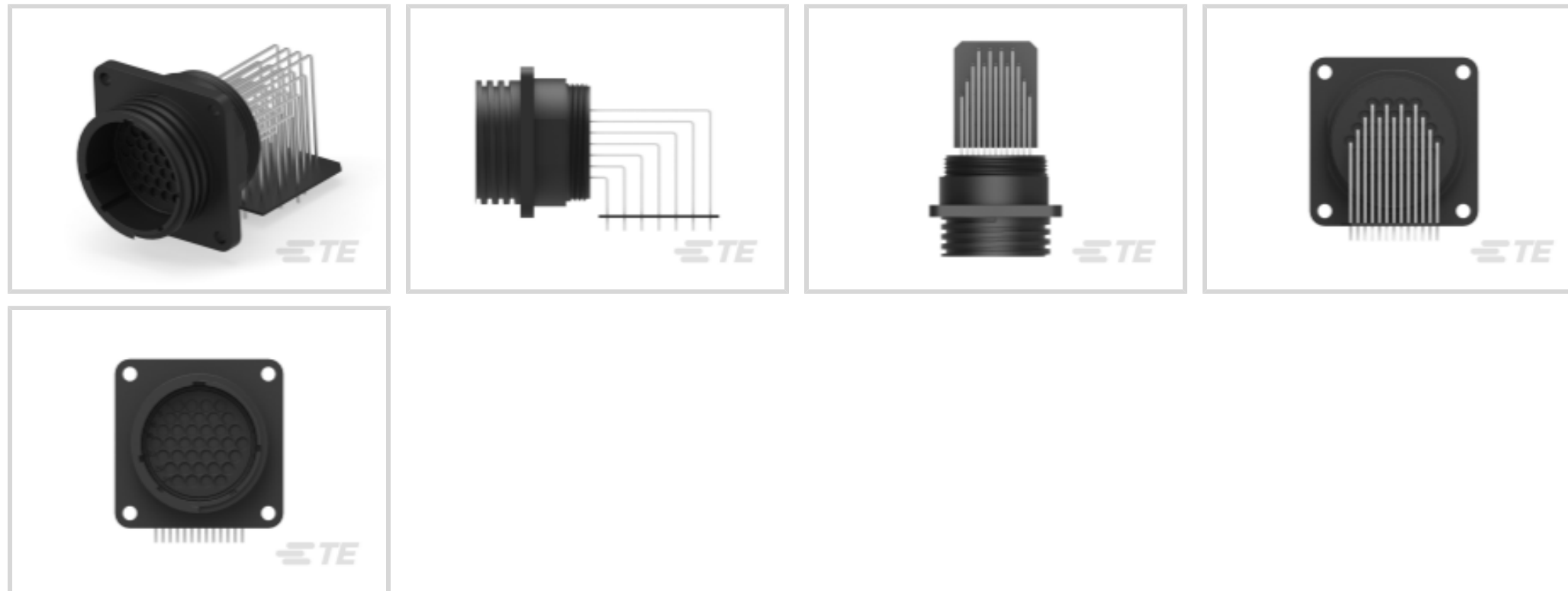

Connectors > Power Connectors > Circular Power > Circular Power Connectors



Connector Product Type: **Connector Assembly**

Operating Voltage: **250 VDC**

Connector System: **Wire-to-Board, Wire-to-Panel**

Number of Positions: **37**

Sealable: **Yes**

Features

Product Type Features

Connector Product Type	Connector Assembly
Connector System	Wire-to-Board, Wire-to-Panel
Sealable	Yes
Connector & Housing Type	Receptacle
Circular Connector Shell Type	All Plastic

Configuration Features

Number of Positions	37
Number of Power Positions	0
Number of Signal Positions	37

Electrical Characteristics

Operating Voltage	250 VAC
-------------------	---------

Contact Features

Reverse Gender	No
Contact Type	Pin

Termination Features



Termination Method to Printed Circuit Board	Through Hole - Solder
---	-----------------------

Mechanical Attachment

Panel Mount Feature Type	Flange with Mounting Holes
--------------------------	----------------------------

Connector Mounting Type	Panel Mount
-------------------------	-------------

Mating Alignment	With
------------------	------

Mating Retention	With
------------------	------

Panel Mount Feature	With
---------------------	------

Mating Alignment Type	Keyed
-----------------------	-------

Mating Retention Type	Threaded Coupling
-----------------------	-------------------

Housing Features

Housing Color	Black
---------------	-------

Housing Material	PA 6.6
------------------	--------

Circular Connector Shell Size	23
-------------------------------	----

Dimensions

Assembly Length	71.88 mm[2.83 in]
-----------------	-------------------

Usage Conditions

Operating Temperature Range	-55 – 105 °C[-67 – 221 °F]
-----------------------------	----------------------------

Fluid Resistance	None
------------------	------

Operation/Application

Circuit Application	Signal
---------------------	--------

Shielded	No
----------	----

Industry Standards

UL Flammability Rating	UL 94V-0
------------------------	----------

Packaging Features

Packaging Method	Tray
------------------	------

Packaging Quantity	8
--------------------	---

Product Compliance

[For compliance documentation, visit the product page on TE.com>](#)

EU RoHS Directive 2011/65/EU	Not Compliant
------------------------------	---------------

EU ELV Directive 2000/53/EC	Not Compliant
-----------------------------	---------------

China RoHS 2 Directive MIIT Order No 32, 2016	Restricted Materials Above Threshold
---	--------------------------------------

EU REACH Regulation (EC) No. 1907/2006

Current ECHA Candidate List: JUNE 2022
(224)

Candidate List Declared Against: JAN 2022
(223)

SVHC > Threshold:

Pb (13% in Component)

Article Safe Usage Statements:

Do not eat, drink or smoke when using this product. Wash thoroughly after handling. Recycle if possible and dispose of the article by following all applicable governmental regulations relevant to your geographic location.

Halogen Content

BFR/CFR/PVC Free, but Br/Cl >900 ppm in other sources.

Solder Process Capability

Wave solder capable to 265°C

Product Compliance Disclaimer

This information is provided based on reasonable inquiry of our suppliers and represents our current actual knowledge based on the information they provided. This information is subject to change. The part numbers that TE has identified as EU RoHS compliant have a maximum concentration of 0.1% by weight in homogenous materials for lead, hexavalent chromium, mercury, PBB, PBDE, DBP, BBP, DEHP, DIBP, and 0.01% for cadmium, or qualify for an exemption to these limits as defined in the Annexes of Directive 2011/65/EU (RoHS2). Finished electrical and electronic equipment products will be CE marked as required by Directive 2011/65/EU. Components may not be CE marked. Additionally, the part numbers that TE has identified as EU ELV compliant have a maximum concentration of 0.1% by weight in homogenous materials for lead, hexavalent chromium, and mercury, and 0.01% for cadmium, or qualify for an exemption to these limits as defined in the Annexes of Directive 2000/53/EC (ELV). Regarding the REACH Regulation, the information TE provides on SVHC in articles for this part number is based on the latest European Chemicals Agency (ECHA) 'Guidance on requirements for substances in articles' posted at this URL: <https://echa.europa.eu/guidance-documents/guidance-on-reach>

Compatible Parts



TE Part # 206150-1
CPC PLUG ASSEMBLY SIZE 23-37



TE Part # 206150-3
CPC PLUG ASSEMBLY SIZE 23-37



TE Part # 206150-2
CPC PLUG, SZ 23-37, SMALL PACK

Also in the Series | AMP CPC



Circular Connector Adapters(7)



Circular Connector Boots & Strain Relief(6)



Circular Connector Caps & Covers(16)



Circular Connector Hardware(3)



Circular Connector Keying Plugs(2)



Circular Connector Seals(36)



Circular Power Connectors(467)



Insertion & Extraction Tools(1)

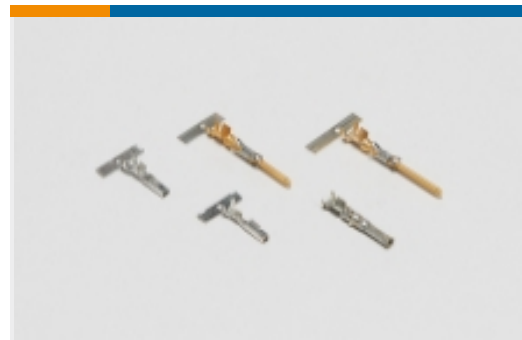

Power Contacts(6)

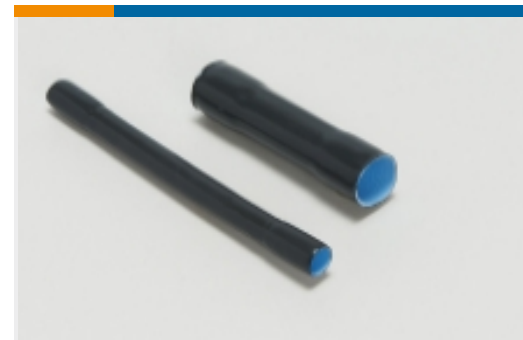

Sealing Sleeves(2)



Unscreened Circular Connector Backshells & Clamps(56)

Documents

Product Drawings

[CPC POSTED RCPT,23-37,R/A](#)

English

CAD Files

[3D PDF](#)

3D

Customer View Model

[ENG_CVM_CVM_796406-1_J.2d_dxf.zip](#)

English

Customer View Model

[ENG_CVM_CVM_796406-1_J.3d_igs.zip](#)

English

Customer View Model

[ENG_CVM_CVM_796406-1_J.3d_stp.zip](#)

English

By downloading the CAD file I accept and agree to the [Terms and Conditions](#) of use.

Product Specifications

[Application Specification](#)

English

Instruction Sheets

[Instruction Sheet \(U.S.\)](#)

English

[Instruction Sheet \(U.S.\)](#)

English

